



Creative **SCIENCE** & Research

Copyright 1996 - 2007

PO BOX 557 New Albany, IN. 47151 USA

Free Energy Catalog!

2008

The Fuelless Engine!
The Sp500 Generator!
Fuel From Water!
The Air Engine!
The Fuelless Heater!
Windmill Generators!
Homemade Solar Cells!
Tesla Technology!

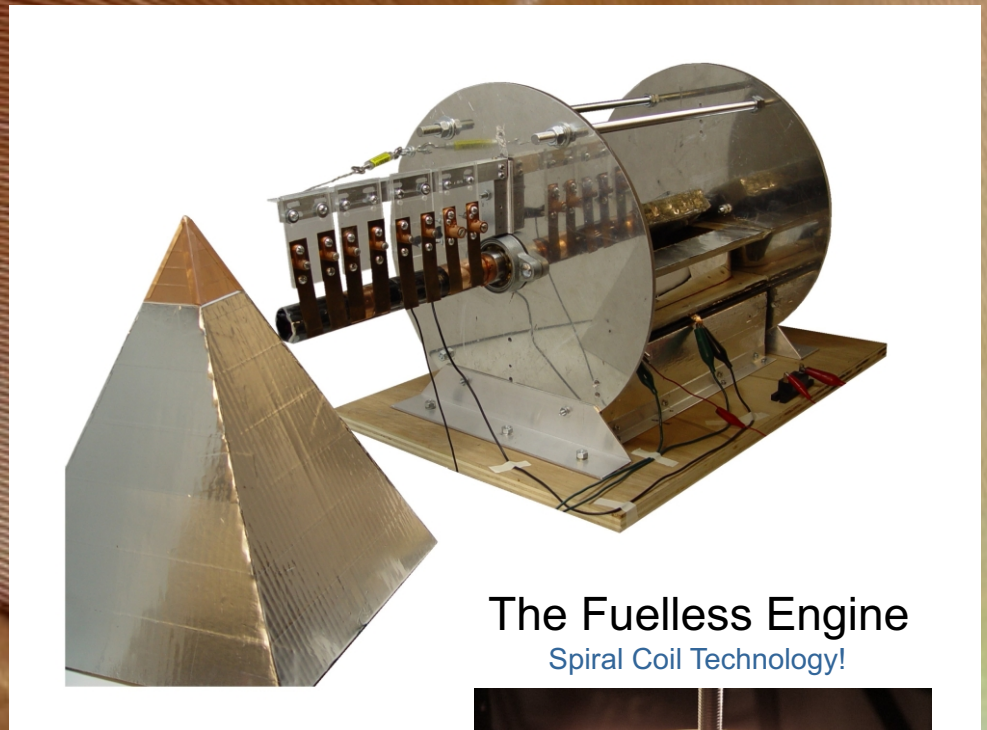

The Fuelless Engine
Spiral Coil Technology!



Homemade Free Energy Devices!

www.FuellessPower.com

Creative Science & Research Copyright 2007



INTRODUCTION

The reason we made this catalog was to raise money for research in the area of alternative energy as well as to make public our findings and discoveries on the Fuelless Engine as well as our new SP500 AC or DC Generator. It is our idea to slowly and carefully introduce these devices to the world by allowing people like yourself to build them in the privacy of your own home or garage. Many of our plans are step by step and easy for many home owners to build. These plans are well illustrated and professionally done and include color photos as well as many drawings.

Question: Is it true you once sold Fuelless Heater kits as well as a Fuelless Engine kit?

Answer: Yes at one time in the early 1990's, but we have to be careful about what we say. We are selling information that has been suppressed for many years and is still being suppressed to this day! We sold many research prototype kits, but we had to stop! At this time, we are only allowed to sell the plans and videos to our inventions! You can only build our devices for personal use only. You can not manufacture or sell these devices. The more people we sell these plans to, the closer we will be to freeing the world from the gas and power companies.

We offer a demo video of our Fuelless Engine showing our low horsepower motor running as well as our larger horsepower motor. Our videos are clear and show many closeups. All of our videos are available on DVD or on Computer CD as well as download. Many schools and universities have purchased our plans and have built our devices. We have hundreds of letters from customers who have built our devices. These letters can be seen at: http://www.fuellesspower.com/23_Satisfied_Customers.htm or www.Fuelless.com or www.FuellessPower.com

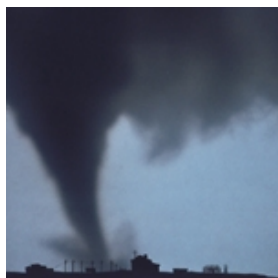

Don't wait until disaster strikes! Be prepared! Every home in America should have an emergency back up system **right now!** Americans must stop relying on the power companies to provide them with electrical power for their homes and business. Have a plan of action before it happens! Think about it. What if your power was shut down for 2 weeks or the entire winter? What would you do for heat or electricity? The sad part is, very few people will listen to my warnings! At least buy a few extra candles, and stock up on some food and water.

Ask not what your country can do for you, ask what you can do for your country.

“ John F. Kennedy “

You can start helping America by helping yourself, by being prepared for emergencies. Waiting until the last minute will be to late.

Free Energy is everywhere! The earth is loaded with free energy and acts as a motor in a perpetual motion state. Hydrogen and oxygen atoms are also a form of free energy constantly being reused over and over! A coil of wire induced by a DC current and then turned off will produce free energy from a collapsing magnetic field! Consider your body as a free energy generator! Our bodies are loaded with free electrical energy provided by the sun, food and the water we drink.

Thank you
David Waggoner

David Waggoner

Websites: www.Fuelless.com
or www.FuellessPower.com
E-mail: Salesdept@FuellessPower.com



Www.FuellessPower.com

Copyright 2005 - 2007 Creative Science & Research

PO BOX 557 New Albany, IN. 47151 USA

The # 362

FUELLESS ENGINE

Invented by David Waggoner of New Albany, Indiana USA
New Albany is located right across the Ohio river from Louisville Kentucky

See our website for more information: www.Fuelless.com

FREE ENERGY - FREE POWER FOR YOUR HOME, GARAGE OR CAR

These type of motors have been seen and demonstrated on the Johnny Carson Show, as well as many local TV news and radio shows all around the country in the early 1970's and 1980's. These motors can be designed to run at any rpm. From 0 - 5000 rpm

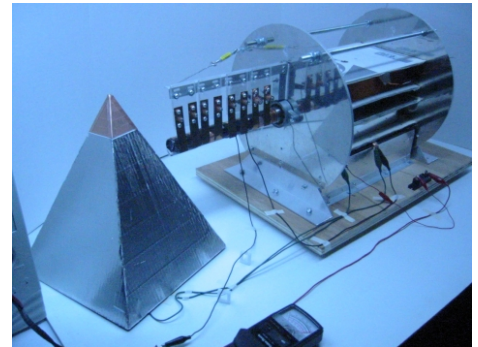

The Fuelless Engine # 362-RC350

I have spent hundreds of hours testing and designing this device! When you buy these plans you will not be disappointed! There is no other engine like it! We have customers that have successfully built this motor. We have made it easy for just about anyone to build this motor in the convenience of there own home, garage or basement. Use this motor to power our SP500 AC generator to generate AC electricity! The motors rpms can be designed to be adjustable. Our prototype designs can be scaled up to run at any horsepower you may desire.

These plans are loaded with information! Plans are professionally done and easy for many home owners to understand and build. David takes you step by step in building this awesome free energy device! Loaded with color photos, professional drawings and illustrations. Our free energy video shows our motor's running inside and out. Many clear and crisp close ups! David demonstrates our large hp motor and at the end of the video he demonstrates one of our smaller free energy motors, input energy versus output energy! By viewing this video you will see that our motor clearly demonstrates more output than input energy!

MANY MAGAZINE ARTICLES HAVE BEEN WRITTEN ABOUT OUR ENGINE! You may have read about us in the 1996 July Issue of Exotic Research magazine. Popular Science has also done a few articles on free energy in the early 1900's and then they suddenly stopped? See our website for more details.

Plans and videos are available on download or on computer CD. Download links can be sent by E-mail. Cds can be sent by air mail. Plans show you how to build a smaller HP motor and explains how you can scale our design up to achieve higher horsepower levels. Using our design, any horsepower can be possible. See our website for the latest prices, Updated news and for more details which are not included in this catalog.

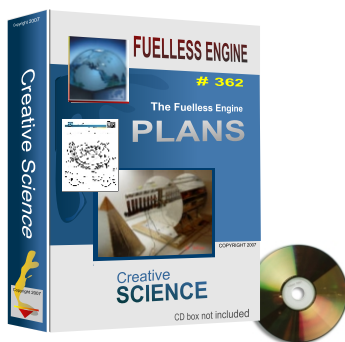

Fuelless Engine Plans 1 - 50 hp \$40.00
Plans are 48 pages long! # 362

Fuelless Engine Plans 50 - 350 hp \$70.00
Plans are 61 pages long! # 362-RC350

DVD VIDEO.....only \$29.95

* Available on DVD, CD or DOWNLOAD

Order # 361V

GUARANTEED TO WORK OR YOUR MONEY BACK!



The Sp500 GENERATOR

Low rpm design
6 to 1800 rpms
0 - 120 V AC or 220 to 240 VAC or DC

**Designed for our Fuelless Engine Motor!
A High Efficiency AC or DC Generator**

Detailed AC - DC Generator Plans! This is a new type of AC generator designed by David Waggoner. You could say, that this is new technology for the 21st century! Designed as an easy to build homemade device that anyone should be able to construct! A breakthrough in AC - DC Generator design! Great as a home generator for emergencies! It was designed to be operated by our Fuelless Engine, windmill or Fuelless Gravity Engine devices. But can be operated by other means as well, such as a homemade high efficiency hand crank generator!

This generator design is very high efficient, unlike any other generator I have seen today! Can easily be designed to operate at much higher voltages than 120 V AC. Great for many high voltage projects. Our prototypes can be scaled up to run at any voltage or amperage output needed. We think we have made these plans easy for just about anybody to build in the privacy of their own home. You do not have to be an electrical engineer to build this.

" I discovered this new type of energy when I was working on another project many years ago. I placed a special coil and aluminum configuration next to a moving N38 Neodymium magnet and what I saw on my volt meter just blew me away! I could not believe what I was seeing! The voltage output was like nothing I had ever seen before. From there I designed the Sp500 generator! I don't think there is a generator like this anywhere in the world!

I personally Guarantee The SP500 to work or your money back! For security reason's I am not showing a photo because I do not want anyone building my device without paying for the plans. I would be giving away my design and my invention and all my hard work! "

Thank you
" David Waggoner "

SP500 AC - DC GENERATOR



Sp500 Generator Plans Only **\$70.00**

Order # Sp500

**GUARANTEED TO WORK OR
YOUR MONEY BACK!**



the Fuelless HEATER

FREE HEAT FOR THE REST OF YOUR LIFE!

**NO MORE HEATING BILLS! • SAFER THAN NATURAL GAS!
NO FLAMES • NO GASES • RUNS QUIET!**



Small Space Heater
rated at 260 degrees F

Learn the secret of this amazing heating device! Simple in design and easy to build!

It is now possible to convert any gas or electric furnace into a free energy heating source! Use, as a stand alone heating device, or as a 2nd heater to lower your heating bills for your entire home, as low as 0-\$20 per month (and that's just the cost to run a fan blower to blow the heat around your home). This invention uses a zinc rod and motor oil inside of an aluminum outer casing. The Fuelless Heater has over three US Patents. Our plans and video show you how to construct a smaller space heating unit, and includes a drawing of a larger home unit. A US patent with drawings are also included in this package. The heat can then be controlled by using your old thermostat. Your thermostat will turn the unit on and off as needed, or you can use the smaller unit as a room to room space heater.

We suggest that you build a small space heating unit first. The larger you build this device, the more BTU's you will get. Drawings show the main heating unit, a small 1 hp free energy motor is then added and is used to blow the **Hot Air** around a room or furnace air duct system etc.. The free energy motor used is our Fuelless Engine #362. You can purchase the plans for \$40

HOW IT WORKS: To start we use a 7" x 11" metal drum, (Which is the outer drum) Then motor oil is poured into the inner can, It does not use oil, it only uses the atoms from the oil which is very safe to use. A small amount of oil is added to the bottom of the can. A zinc rod is placed in the center of the inner drum, more devices and parts are then added. The unit is turned on, and the end result is heat! A large amount of safe heat, in the form of a spiral vortex reaction, which creates a strong chain reaction within the atoms of the oil creating the enormous amount of heat! The zinc rod can be purchased at most hardware stores, or on the internet. Zinc plated long bolts can be used as well. Most hardware store bolts are zinc plated.

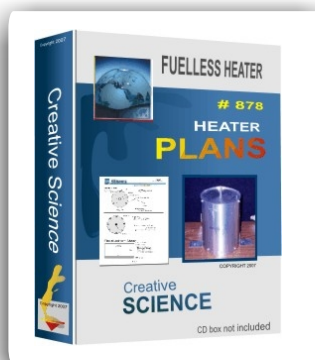

Fuelless Heater Plans

Only **\$40.00**

Order # 878P

* Available on CD, Paper or Download.

Plans and Video

Only **\$59.95**

* Available on DVD or CD only

* Step by Step Video
878PV

**GUARANTEED TO WORK OR
YOUR MONEY BACK!**



PART 1

FUEL FROM WATER

Learn how to build a **Fuel Cell!** Turn water into usable energy by using electrolysis. Easy for most homeowners to construct and apply. Water is made up of hydrogen and oxygen atoms, and it is not hard to split the two. Electricity is applied to tap water or free rain water. With this fuel cell you can store the gases produced in propane tanks. You can then use the gas to cook or heat with as well as run a small gasoline engine. Can be used as an additive to gas or used by itself. Hydrogen burns very clean! This can all be done right in your own backyard.

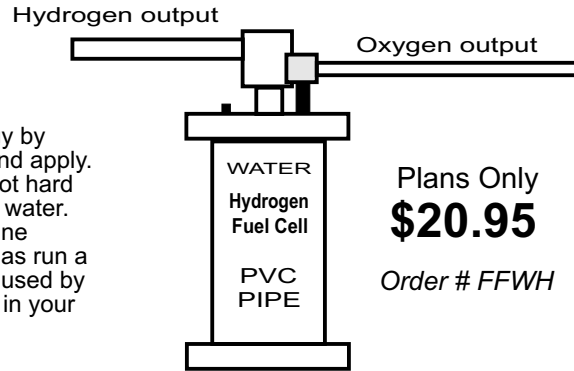

Plans Only
\$20.95

Order # *FFWH*

PART 2 *Fuel From* WATER

You will also need # FFWH Part one \$20.95 to build this and get a better understanding!

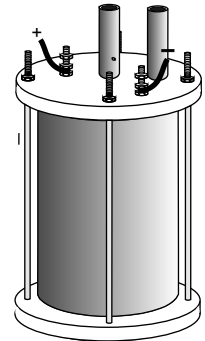

Run your car, truck or home generator with water!

Many industrial vehicles as well as some cars in America already run on propane gas as well as natural gas. This helps set the stage for hydrogen as an alternative fuel for cars or trucks. Hydrogen gas can replace propane gas using just about the same set up and configuration as propane driven vehicles. Many back yard researchers world wide are already using water as a alternative fuel. Now we may see America getting closer to seeing this fuel on the open market! But some of our customers are not waiting! Many right now are building these fuel cells to run their gasoline engines and you can to! Think about it, instead of going to a gas station to fill up on high price gas, you simply fill your tank with water instead. I have talked to an old man down in Kentucky who has been secretly running his car on water for years! The old method has been to store the hydrogen and the oxygen gases in large heavy storage tanks, which has proven to be very dangerous! But there is a new method that is safe and easy to do, by simply storing the water and splitting the gases on demand and directing them into the carburetor.

Plan with US Patent only **\$20.95** Order # SMW

All plans available on computer CD, paper or download.



US PATENT / Tesla Turbine Engine

The Tesla Turbine:

Learn how to build a Tesla turbine engine. Many of our customers already have! This engine will amaze you! A 300 hp engine could be possible which is no bigger than a man's hat. It has been told that Tesla built an engine that could fit in the palm of your hand and can produce 300 hp at 2,000 rpm's! It is powered by air or compressed Steam. This engine can be easy to build and geared down to power a home generator or a car or an electric car. Great as a super high efficient steam engine to power any home generator system. Simply use an old pressure cooker filled with water. All You will then need is fire wood and a high pressure line coming from the pressure cooker to the Tesla turbine engine which can then be connected to a 120 v ac or dc home generator or our Sp500 AC generator.

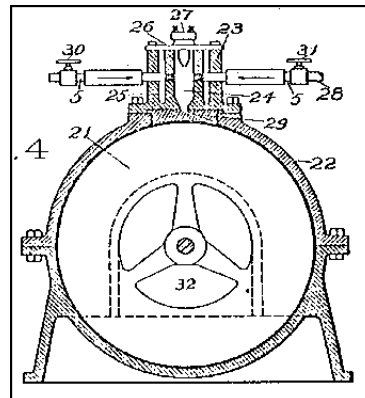

Invented by Nikola Tesla in the early 1900's and suppressed!

US Patent Only \$11.95 #393

See Our website for plans that are not included in this catalog.
See us at: www.fuelless.com
or www.fuellesspower.com

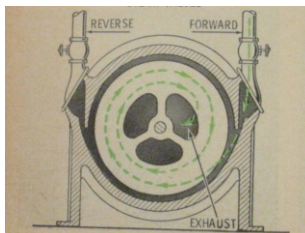

THE AIR ENGINE

AS SEEN ON **Headline News**
Jan. 1998

The Air Engine: Run any car or truck on air! This US Patent (and added info) shows how to convert a V-8 gas automobile engine using compressed air. The gas tank is removed and thrown away! The carburetor, exhaust system and cooling system are no longer needed. The engine is easily converted to run on compressed air. Using air hoses and solenoid switches that fit directly into the spark plug hole. Each piston is then timed by using the existing timing system of the engine, using 8 small electrical on/off solenoids. This engine is just as powerful as a V-8 Engine running on gasoline! Bonus info is included that shows photos of an actual air car.

The result is **clean air with no deadly fumes.**

US Patent w/bonus info Only \$16.95 order #400

YOU MUST SEE THIS PATENT FOR YOURSELF, JAPAN IS TRYING TO MARKET IT NOW!

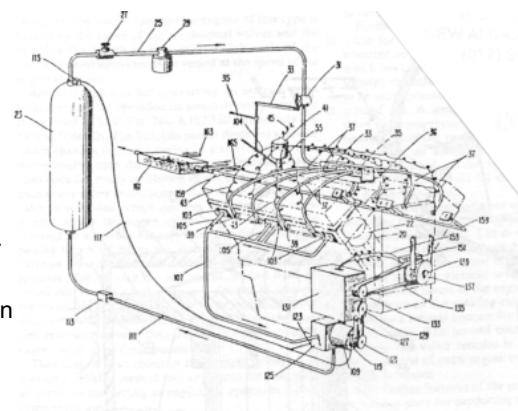



The Fuelless Gravity Motor

Rated at up to 500 RPMS:

The Fuelless Gravity Motor is what we invented before we discovered the Fuelless engine on page 2. You will not be able to run a car with it, but you can build one to generate electricity.

This motor uses gravity and balance as its main source of power and unlike many so called Gravity engines out there, this one really works! In 1991 we did a patent search on this device and we found no other gravity engine like it. This device does use a small input of electrical power to get the free energy reaction started. Most free energy devices we have seen, all use some form of energy to get the free energy reaction started. The only free energy device I have seen that does not use input energy is an all permanent magnet motor. This device is easy to build and will amaze all your friends.

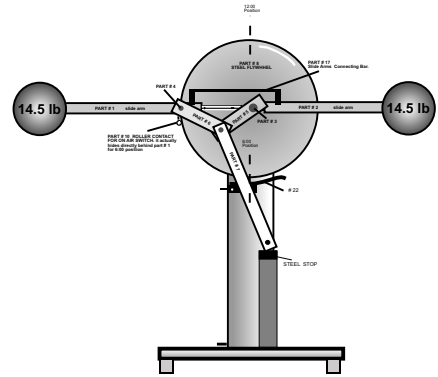

GUARANTEED TO WORK OR YOUR MONEY BACK!

DVD VIDEO

Only **\$19.95**

* Available on DVD or CD only
FGE3

Step by Step Plans Only **\$16.95**
Order # FGE2

Video is not yet downloadable at this time, but can be sent on a CD or DVD disk by air mail.

High Voltage Electromagnets

Will handle up to 800 volts 1-4 amps at 60 KHZ Size 2"ht x 4" L x 3"w

Made with a special hard to find iron core!

These magnets are great for many free energy devices and many other science experiments.

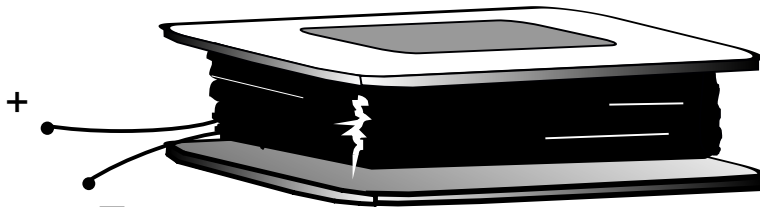

PRICE: \$.....Call or write us.

Order # HVEM

Creative Science & Research P.O. BOX 557 New Albany, IN. 47151
(See last page for ordering information)



HIGH VOLTAGE PLANS

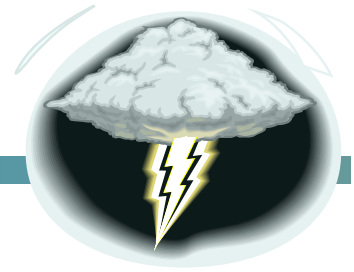

MAKE YOUR OWN High Voltage Capacitors

200 - 50,000 volts

Step by Step PLANS \$ 9.95 order # HVC1

Great for many free energy projects! These plans are packed with more information than you may use in a life time. A must for many free energy devices. Great for many anti gravity lifters experiments, or one could say anti gravity air craft projects as well. Includes many different designs and safety info. It's easy to scale these designs up to any desired voltage or capacitance. All our plans are available on computer cd in color or on paper in black and white.

Capacitors that recharge themselves!

This is FREE ENERGY that many research groups already know about. Building this type of capacitor is like building a permanent magnet, in that it acts to have energy even after you discharge or release its energy. But the energy coming from it's plate's is electrical! Up to 20,00 volts DC. PLANS \$9.95 order # H757

It is claimed by some to charge, discharge and then recharge over and over up to 12 yrs!

HIGH VOLTAGE ELECTROMAGNETS

As seen on page 3 of this catalog. You can build them to any size or power range you desire! The plans will also show you how to build a home made automatic coil winder as well, You will then be able to wind as many coils as you want very quickly.



Plans \$16.95 order # HVEMP

Video w/plans \$19.95 # VPEM

Homemade Solar Cells

Learn how to build your own powerful Solar Cells! You can print them in the privacy of your own home or garage! This is information that Solar cell companies do not want you to know. It's simple and can be easy. by simply using the art of screen printing and your outdoor grill to bake them, you can make as many powerful solar cells as you want! You can cover your entire roof! These cells can be just as powerful as the commercial Silicon cells. Why not print one as big as 16" Diameter or more. 16" D could be possible to get 12 vdc w/high amps with just one cell.



Example only: Some chemical inks used must be handled with care and kept out of reach of children.

Plans/ Patent only..... \$16.95 #401

Screen Printing Video only..... \$19.95 #402Video

Screen Printing Booklet only.....\$9.95 #402booklet



The High Efficiency GENERATOR

This generator is not our awesome Sp500 Generator, but it is great for research purposes and exposes new ways to generate electricity with no moving parts. Very educational and can open an entire new road for anyone interested in AC / DC generator technology. A must for any research group or high school science fair project.

High Efficiency Generator



Example only: Patent Pending 2003-2007 HFG9

Plans only **\$16.95** # HFG9



SP500 Step by Step Plans only **\$70.00** # Sp500

Homemade Batteries

Great for emergency back up lighting, shelf life is about 70 yrs!
Also great for School Science Projects as well as serious HV research.

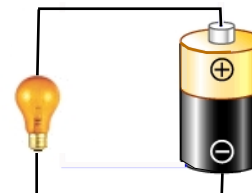

Just about everything you ever wanted to know about making your own homemade batteries. Learn how to build a Clorox Bleach Battery. This type of battery is very powerful! The plans will teach you the proper Clorox mixture and show you how to construct batteries using PVC pipe from a hardware store. Clorox Bleach Batteries are very powerful but they only last a year, the metal copper corrodes too fast. But there are other metals we found that you can use in plain tap water that corrode more slowly, such as stainless steel.

You can use plain tap water as your main source of power! It maybe possible to simply fill up the batteries with water every 3-6 months. We estimate battery life to be up to about 10 - 15 years. The water and the 2 metals will produce the electricity, therefore you will never need to charge these batteries, just refuel them with water!

Plans only **\$14.95** order #396

Plans are well illustrated and professionally done. You can order by mail or credit card.



Build Your Own Homemade WINDMILL

Possible to produce enough electricity to run your entire home, with nothing but the wind!

High Efficient!

Designed by David Waggoner of Creative Science & Research.

This windmill is not like the old windmills used before the 1980's. The old windmills never produced enough amperage or wattage to do much of anything. This is truly a new discovery for the 21st century. If enough of these windmills were placed all across the American costal lines, there would be enough power to run the whole entire country. This is new technology! We have yet to find another easy to build high efficiency windmill like this one. You will be amazed at how much free energy this one windmill can produce. We will teach how to make windmill blades that are easy to build. You will love these plans, they are packed full of information. Easy step by step design. Plans will include our high efficiency low rpm generator design. You can even take this generator even further by using super conducting wire for your generator coils! Much more high efficient than copper wire or cooled copper wire coils.

To take this system even one step further. We have now designed a new low rpm generator that is even better than the high efficiency generator included in these plans. (See our Sp500 ac or dc low rpm generator, plans are \$70.00).

Once you learn the secrets of David's new discovery, you can then scale the system up to any desired amperage, wattage or voltage output to output AC or DC. 14 volts, 120 volts, 220 volts, 500 volts, 1,500 volts, or 3,000 volts. But windmills are most commonly used to output 14 - 20 volts DC to charge a bank of 12 volt deep cycle batteries. 4 to 7 Batteries are connected in parallel and are then connected to a 110 to 120 volt AC inverter. The inverter steps up the 12 volt dc to 120 - 140 volts DC then converts the DC to AC and steps down the voltage to 110 - 120 volts AC household current. You can build our homemade 5000 watt inverter or buy one on the internet or at any automotive store. You can purchase deep cycle marine batteries from stores such as K-mart, Sears, the internet or a marine boat supply company or store. You do not want to use a 12 volt car battery, they are not designed for deep discharge.

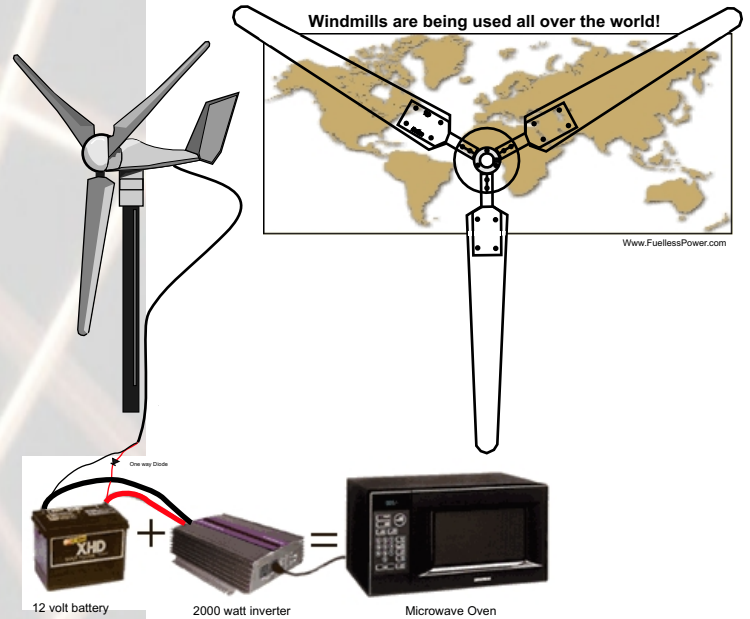

Step by Step PLANS

Only **\$20.95**

Order # 412

GUARANTEED TO WORK OR YOUR MONEY BACK!



Free Electricity From **THE SKY**



Free Electricity from the Sky! The entire earth is being bombarded with high and low frequency electrical energy, Some of that energy is from TV, Radio, Microwave satellites, Cell phones and 20,000 volt electrical power lines etc... Electricity moves through the air all the time. Even before these inventions the earth has been bombarded by electrical energy traveling through the air, from the sun, the stars, and within the earth itself. there is over 20,000 volts of electricity in our upper atmosphere all the time, surrounding the earth just waiting to be tapped into, and many thousands of people are doing just that. This system has been used for years by big brother, for hidden FM transmitters etc.... It is possible to get enough energy to run motors, lights, etc... David knows of a man that lives high up in a mountain area, who ran a large cable up to the highest peak and connected it to a large metal grid, the other end was connected to his cabin, which provided enough electricity to run his whole entire cabin!

Plans \$14.95 order # 371

Burnt Out Fluorescent Fluorescent Light Bulbs



Burnt out Fluorescent Light Bulbs! Don't throw them out! Reuse them!

David has invented a way to relight Fluorescent bulbs! you can use them for a life time and they will never go out! You will never need to throw away another fluorescent bulb ever again.

Plans \$9.95 order # 377

Make Your Own Light Bulbs!



A very fun science project for the whole family! it's easy, never buy another bulb again! Information bulb manufactures do not want you to know! Includes Thomas Edison info. Some Edison bulbs we were told would last 50 times longer than the bulbs sold today!

Plans \$9.95 order # 386

500 volt Power Supply!

500 VOLTS DC From a bicycle generator, easy to build! Generates an enormous amount of earth shaking power. attached to a bike or you can simply turn with your hand. 50 kv to 100 kv is possible by scaling up these plans!

Plans \$7.95 order # 373





NEW

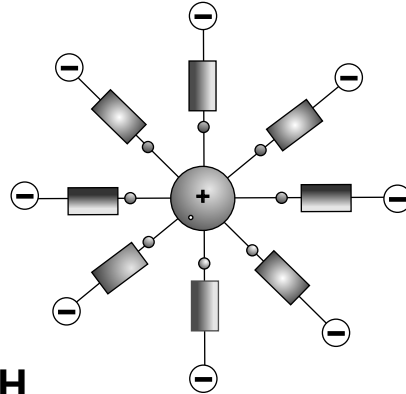

FREE ENERGY FROM THE EARTH

Extracting free energy from the earth has been around since the 1800's, but no one has been able to do what we have discovered. Patents from researchers since the 1800's concerning free energy from the earth have been weak, not enough power in a small area and the cost was too great! We have found that the earth is loaded with electricity! The earth's core is radioactive. This radioactivity generates heat and produces motion through it in the form of convection currents.

There are many secrets which we are going to share in these plans. We have found this new discovery to be one of the most fascinating projects we have ever worked on. if used with Rick's new step up transformer technology makes this an even more powerful source of free energy than anyone has ever seen!

Question: Is possible to get enough energy to help power a home!

Answer: Yes! 120 vdc would be converted to AC using a simple pulse converter or coil set up. Keep in mind that any amount of voltage desired can be obtained! 12 volts is more practical and cheaper. But also take note, that the higher the voltages and amperages you wish to produce, the higher the cost. It is less costly if you produce higher voltages with low amperages. Cost can be as low as \$50 or less. It is more practical and cheaper to build our Fuelless Engine and our Sp500 AC generator to help run your home than to build a 120 volt ac x 50 amp earth device. But don't get me wrong, this is a discovery that everyone should build and learn. This invention would be great for emergency lighting, for example, there are LED light bulbs that will last for about 70 yrs and only take small milliamps and small voltages to run and are super bright! One could build a lower cost method and produce about 12 volts x 2 amps, then place these special 70 yr light bulbs in every room in there home and garage and have 24 hr a day free home lighting or emergency lighting! This type of system would also be great for 3rd world countries!



GUARANTEED TO WORK OR
YOUR MONEY BACK!

Available on
Computer CD
or Paper

Free Energy from the Earth Plans Only **\$19.95**

459P



PERMANENT MAGNET MOTORS!

Free energy using Radio Shack ceramic bar magnets. Learn how to build 2 simple motors that will actually move by the free power of magnets. You will learn the correct way to angle the rotor and stator magnets. The plans will explain why and how they work. The horse power will depend on how strong your magnets are. These plans are for research purposes only. I have spent many nights awake learning how to use these magnets, many hours of research have gone into these 2 simple designs. Also included as free news is the Howard Johnson perm magnet motor. Learn how to build from this 1980 article.

“ David Waggoner “

FOR RESEARCH PURPOSES ONLY!



Available on Computer CD or Paper

Only **\$19.95**

376

Perm Magnet Motor Plans

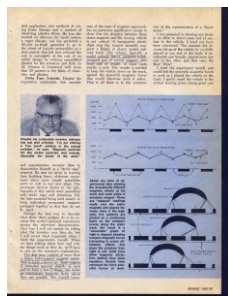

FREE ELECTRICITY from the PHONE CO.

David Waggoner has invented a way to pull enough electricity from the phone company to light a 150 watt light bulb, and it's all legal! He has developed a way to charge batteries and still use your telephone without any problems. David's special circuit design is easy to construct and will give you awesome results!

Plans only **\$9.95** Order # 359

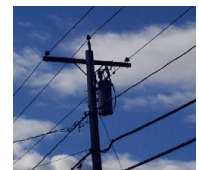

Anti-Gravity UFO Aircraft (Fact!)

David was concerned about offering this US Patent, he was not sure how some customers would react! But this Patent is proof that they are real and do exist! We are offering just one of many hidden to the world! This official US patent will show you that the United States Gov has indeed known about them for many years. An Official US PATENT Dated April 1967.

Actual drawings and plans of a USA - man made **UFO flying saucer.**

US Patent only **\$9.95** #409

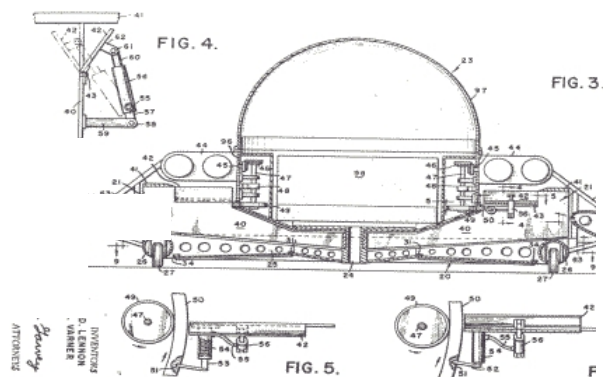

FILED Oct. 12, 1967

NEW

CD Package Deals

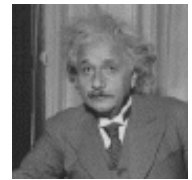
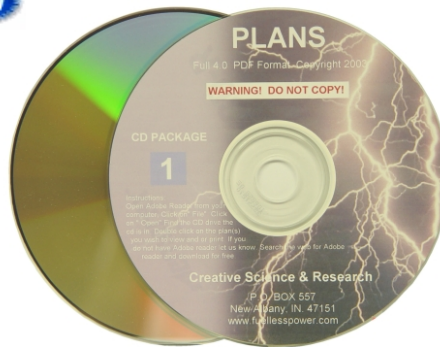

Plans are sent to you on a CD Computer disk in PDF Adobe Format, You can then view them and or print them out from your computer. We also offer a download option.

If you have already ordered from us before, you can deduct the amount you paid for the plans only, do not include the shipping you paid or any videos. Not to exceed \$125 or CD will be full price.

1. CD Package #1 Includes **all 33 plans** & 3 videos offered on our website!
All 33 plans & Videos only **\$300** you save over **\$351.60**

Includes every plan we have on our website and catalog, plus 1- Fuelless Engine Video & 1 - Heater Video

As a Bonus we are including our New Sp500 AC Generator Plans!
A \$70 value!

LOADED WITH INFORMATION!

2. CD Package # 2 Includes 17 plans only **\$150** you save **\$120**

CD # 2 Includes:

#362 The Fuelless Engine (low hp), #878P The Fuelless Heater, #579 The 5000 watt inverter, #400 The Air Engine, #401 Homemade Solar Cells, #402 Solar Cell Screen Printing Booklet, #396 Homemade Batteries, #FGE2 The Gravity Engine, #376 Permanent Magnet Motor, #393 The Tesla Turbine, # Hfg9 High Eff. Generator, #386 Make your own light bulbs, #HVEMP HV Electromagnets, # Ffwh Fuel from water part 1, # Smw Fuel from water part 2 #409 Anti-Gravity Aircraft Patent. #HVC1 HV Capacitor Plans.

Please Include shipping charges see our catalog or web order form.

To order see our website or fill out the order form on the back page and mail to us.

Creative Science & Research
PO BOX 557
New Albany, IN. 47151-0557

www.fuellesspower.com

or www.fuelless.com / E-mail us: SalesDept@FuellessPower.com



Creative SCIENCE

& Research

E-mail: SalesDept@fuellesspower.com

PO BOX 557 New Albany, IN. 47151 USA

www.FuellessPower.com

All our plans are now available on CD in .PDF format or Downloading.
If you need plans on paper please add \$14.95 to the total.



ORDER FORM



Name _____

Address _____ City _____

State _____ Zip _____

* E-mail _____ Country _____

Credit Card # _____ Expiration Date: _____
Month Year

Credit Card Type: _____ Phone # _____
Visa, Master Card

Send my order by: E-mail Downloading By US Priority Mail

Please select a box(s) below.....

Order Number	Qty	Item Description	Price Each	Total
1				
2				
3				
4				
5				
6				
7				
8				
9				
10				
11				
Shipping charges		MERCHANDISE TOTAL		
\$8.95 USA / Canada Air mail		Shipping charges		
\$ FREE download processing Fee		TOTAL AMOUNT		
Orders outside the USA \$14.95				

Send Plans to me on Computer CD

Send Plans to me on Paper
 Add \$14.95 extra

Send VIDEO(S) to me on Computer CD

Send VIDEO(S) to me on DVD

Add \$14.95 to total
 If you need plans on paper.

Guaranteed to work or your money back! Personal check, Cash or Money Order.
 Postal money orders are faster, see your post office for details.